

サイドレール側溝 500型 断面図

単位：mm

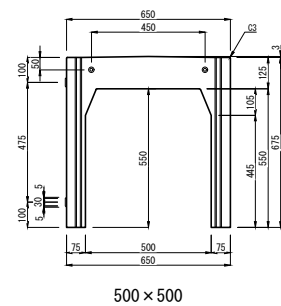

500 × 500

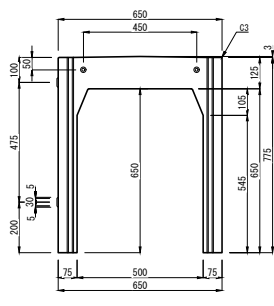

500 × 600

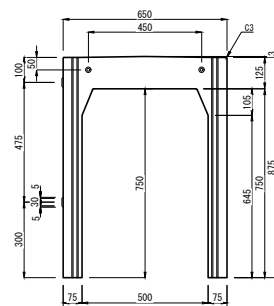

500 × 700

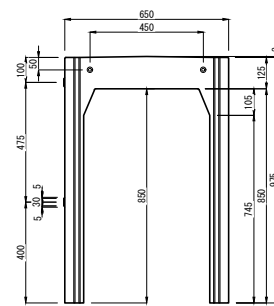

500 × 800

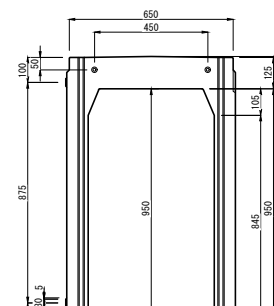

500 × 900

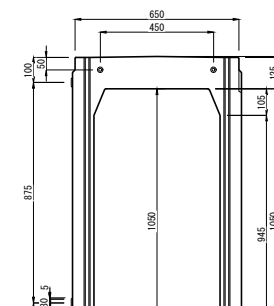

500 × 1000

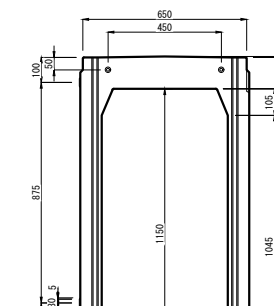

500 × 1100

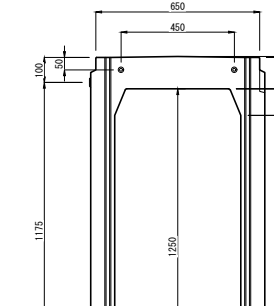

500 × 1200

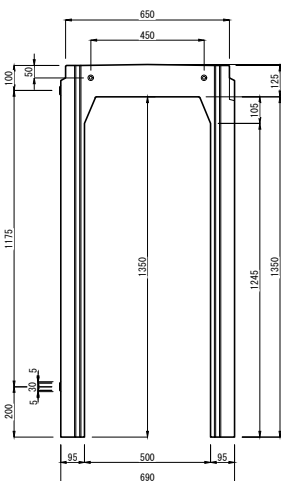

500 × 1300

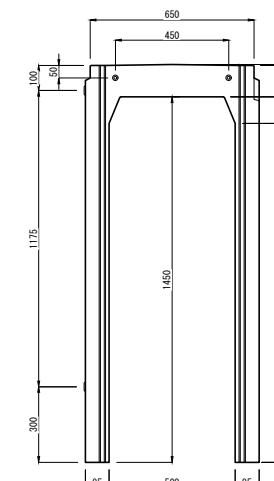

500 × 1400

サイドレール側溝 600型 断面図

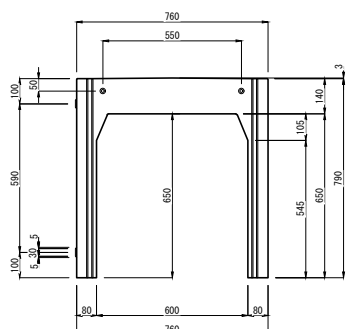

600 × 600

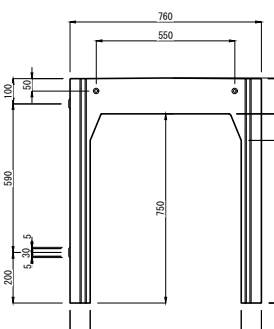

600 × 700

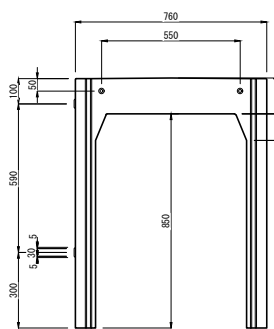

600 × 800

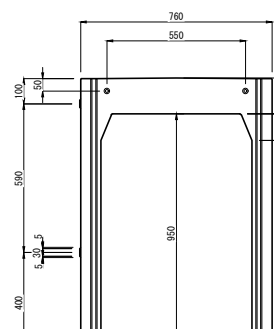

600 × 900

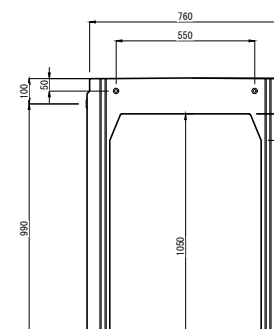

600 × 1000

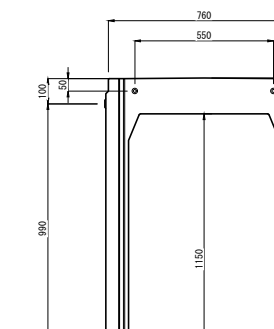

600 × 1100

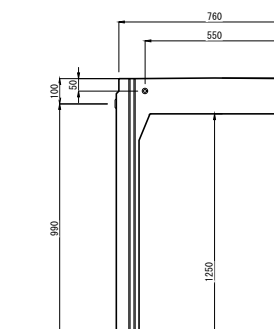

600 × 1200

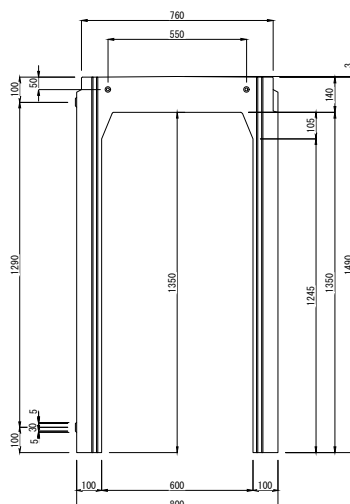

600 × 1300

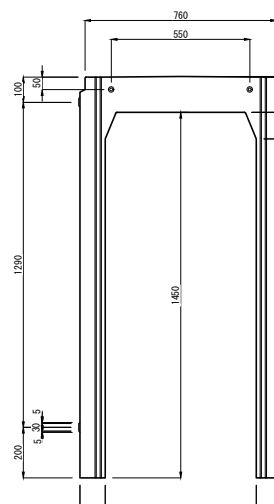

600 × 1400

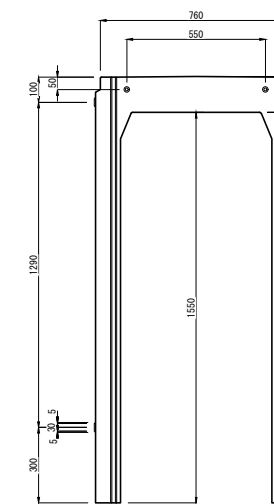

600 × 1500

製品名	サイドレール側溝 断面図	製 図	2021. 11. 24	 東洋コンクリート工業株式会社
規 格	500型・600型	図面番号		
参考質量	縮 尺	1/30	設 計	