

深溝U字溝 浸透用・可変用[KDSD, KDRD] (底穴開き)300型断面図

KDSD 300×500

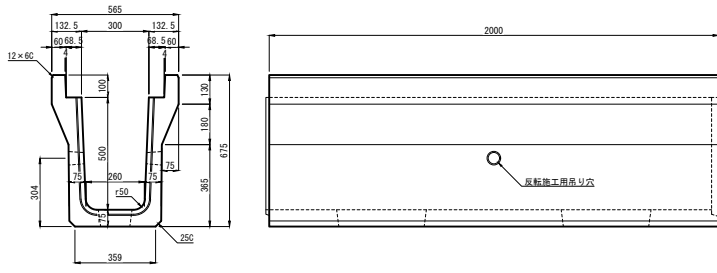

KDRD 300×500

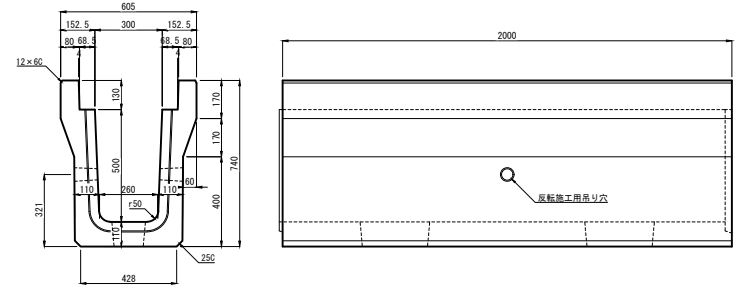

KDSD 300×600

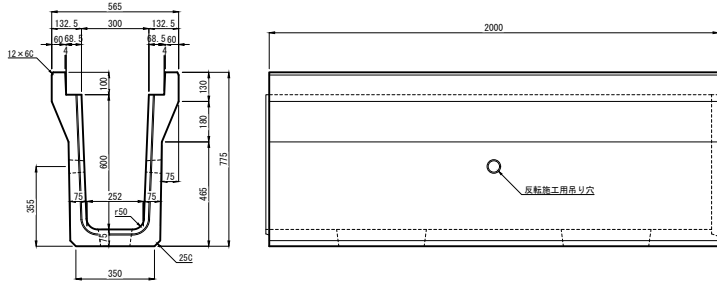

KDRD 300×600

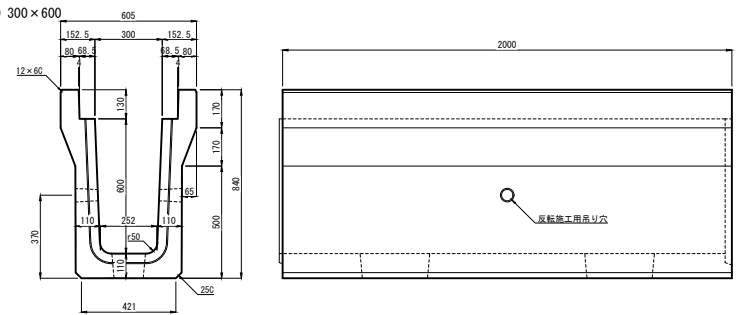

KDSD 300×700

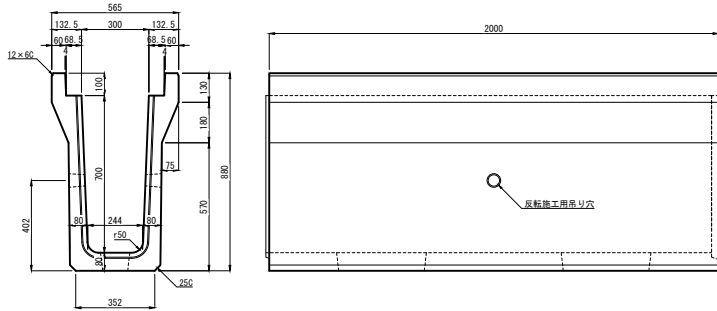

KDRD 300×700

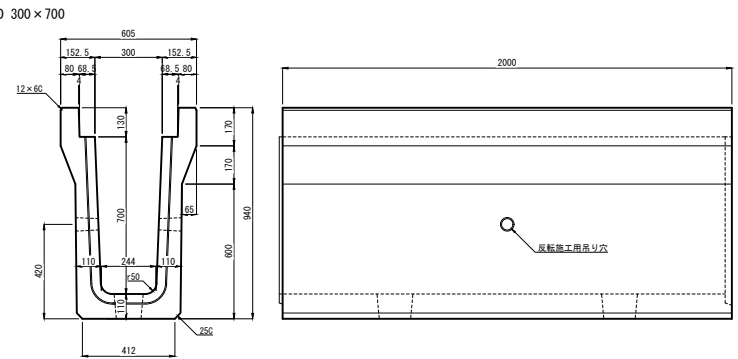

KDSD 300×800

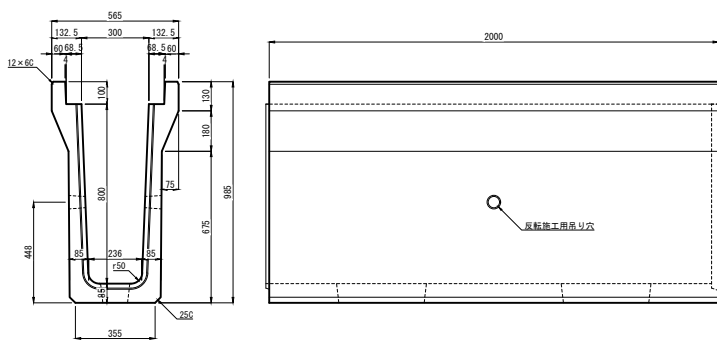

KDRD 300×800

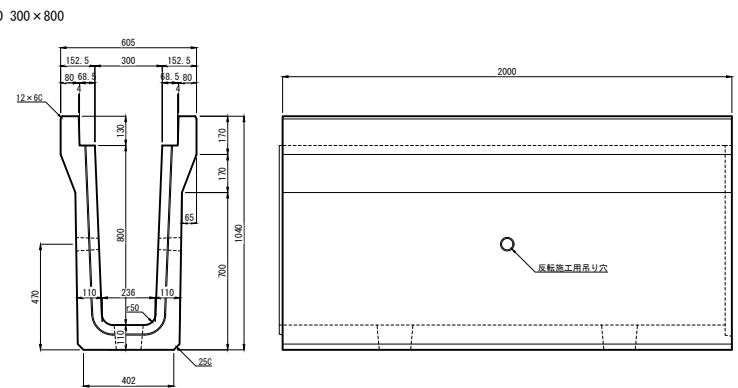

KDSD 300×900

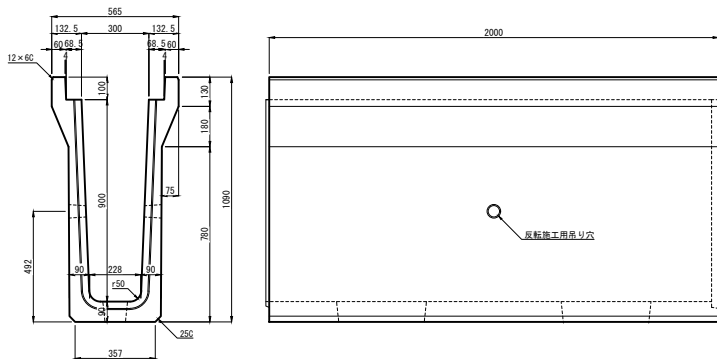

KDRD 300×900

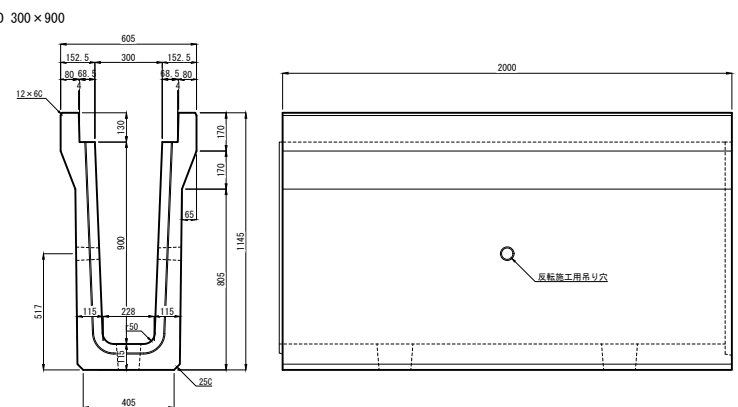

KDSD 300×1000

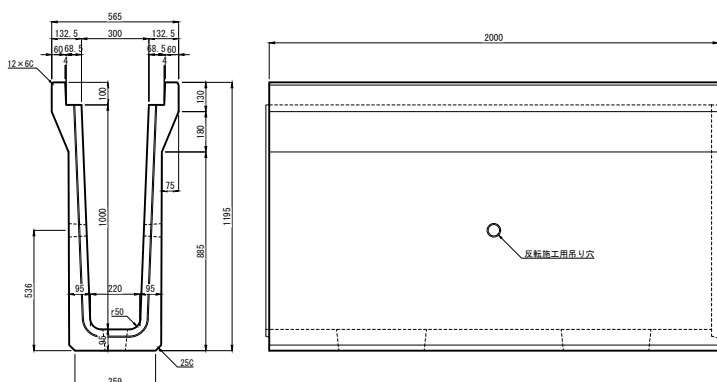

KDRD 300×1000

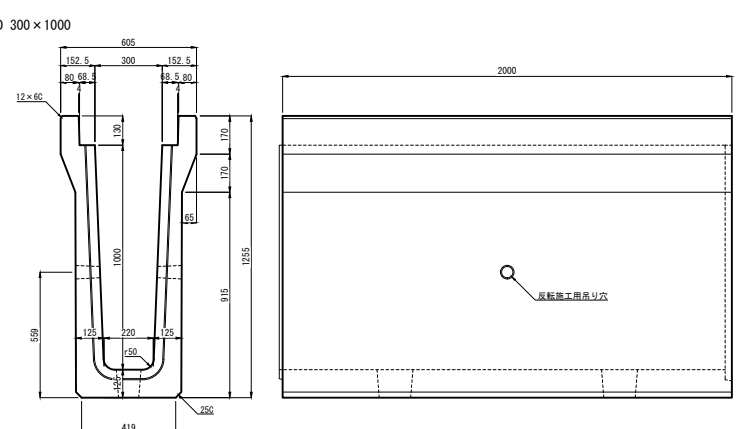

深溝U字溝 浸透用・可変用 [KSD, KDRD] (底穴開き) 400型断面図

KSD 400×600

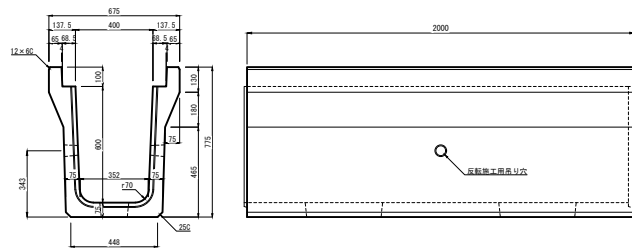

KDRD 400×600

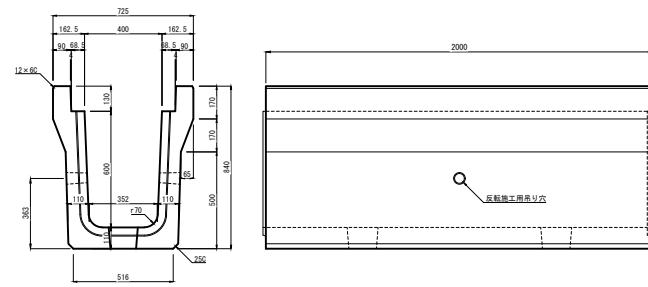

KSD 400×700

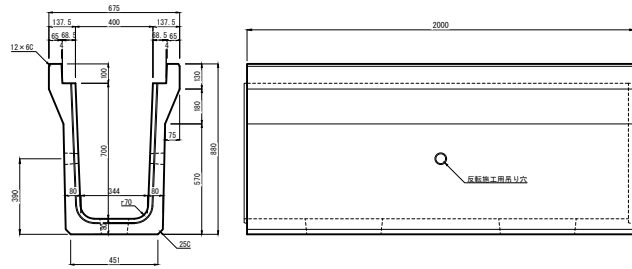

KDRD 400×700

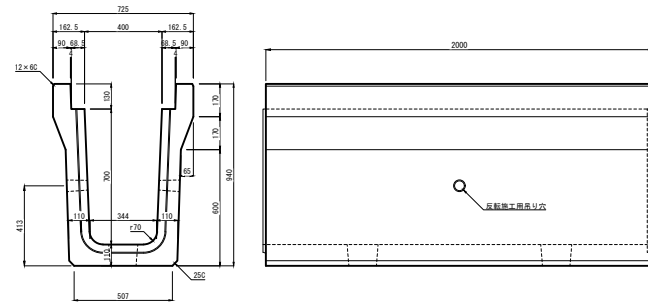

KSD 400×800

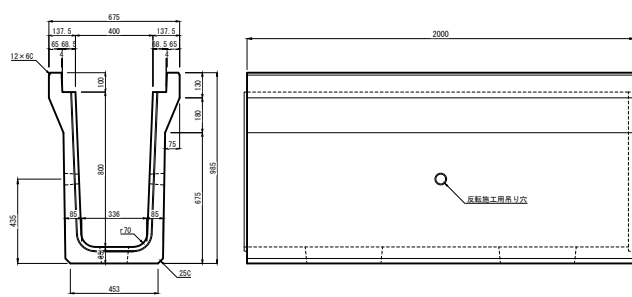

KDRD 400×800

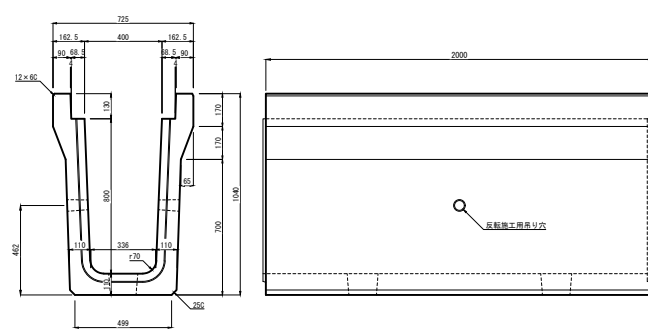

KSD 400×900

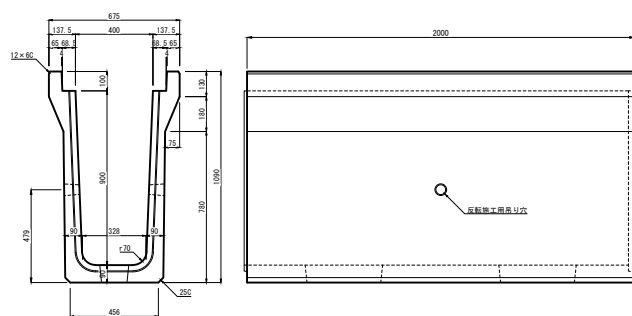

KDRD 400×900

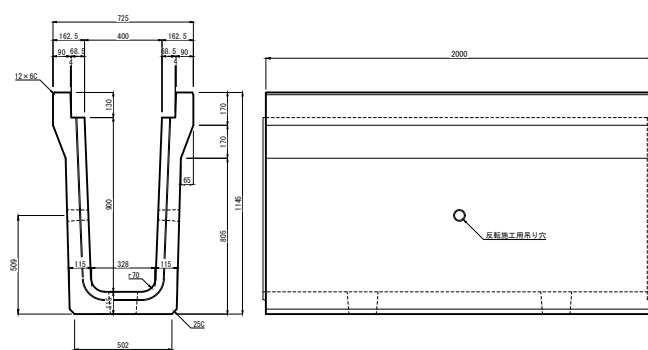

KSD 400×1000

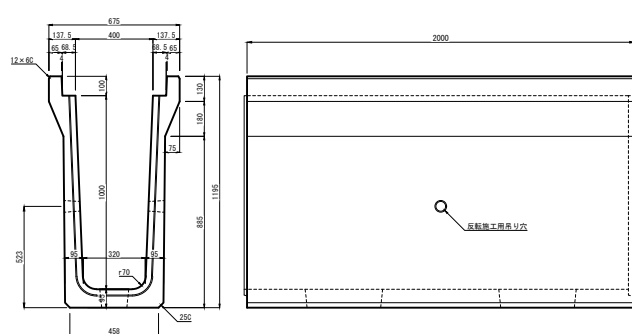

KDRD 400×1000

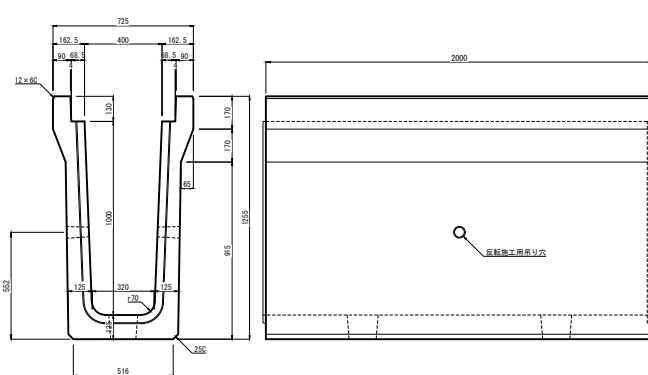

KSD 400×1100(特)

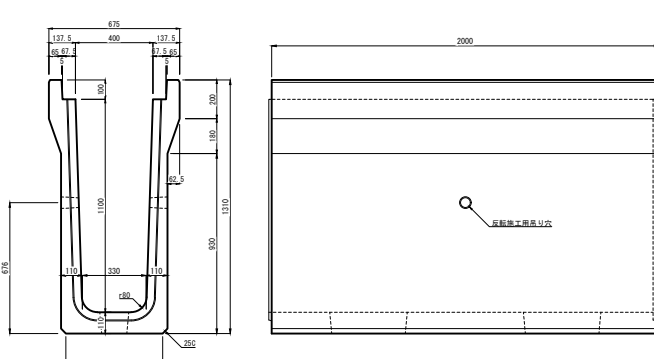

深溝Uスリット浸透側溝 [KSDS, KDRDS] 300型断面図

KSDS 300×500

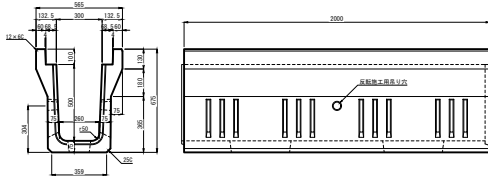

KDRS 300×500

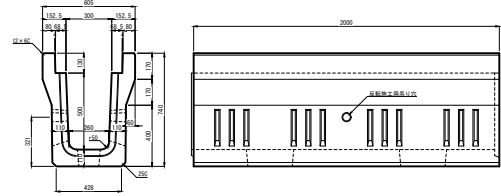

KSDS 300×600

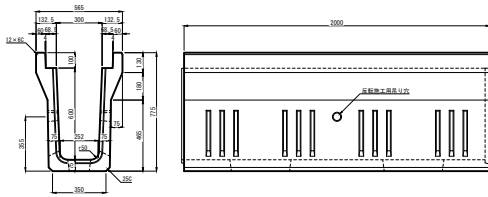

KDRS 300×600

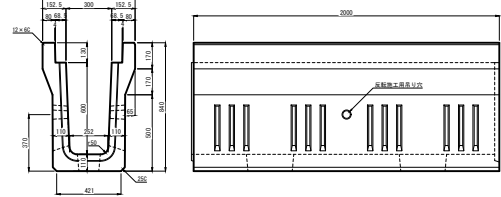

KSDS 300×700

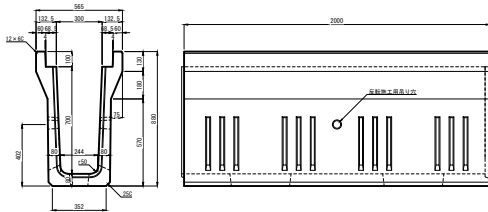

KDRS 300×700

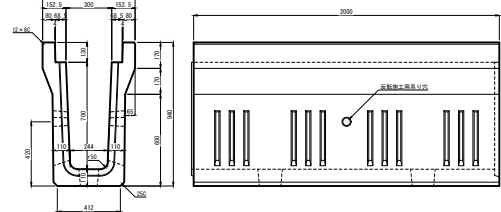

KSDS 300×800

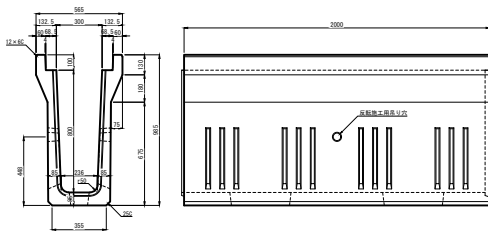

KDRS 300×800

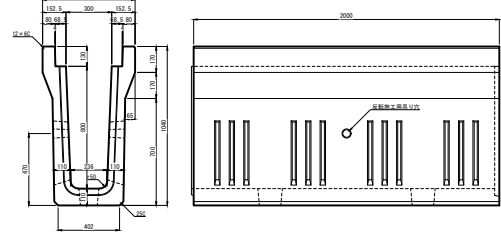

KSDS 300×900

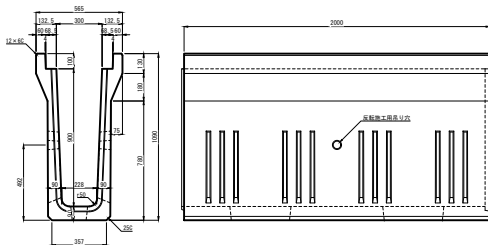

KDRS 300×900

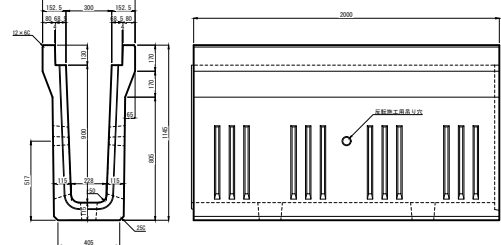

KSDS 300×1000

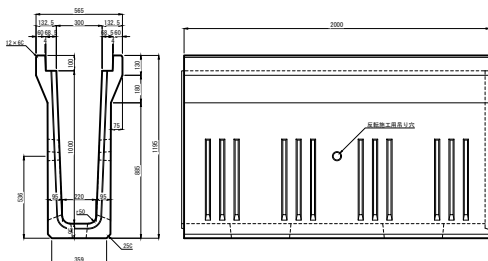

KDRS 300×1000

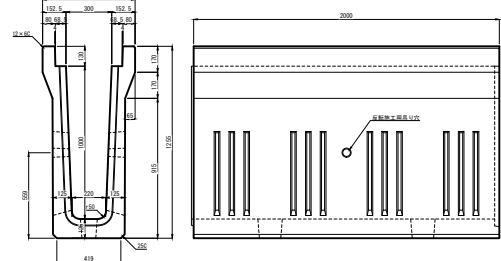

深溝Uスリット浸透側溝 [KSDS, KDRDS] (底穴開き) 400型断面図

KSDS 400 × 600

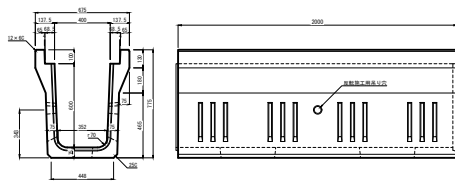

KDRS 400 × 600

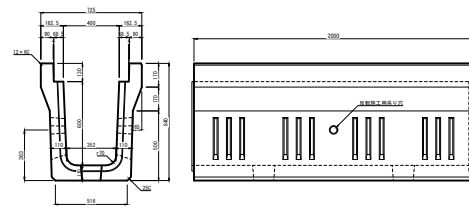

KSDS 400 × 700

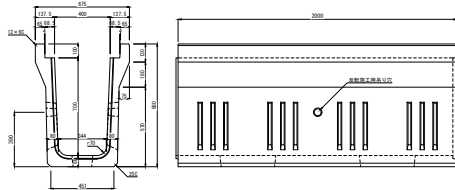

KDRS 400 × 700

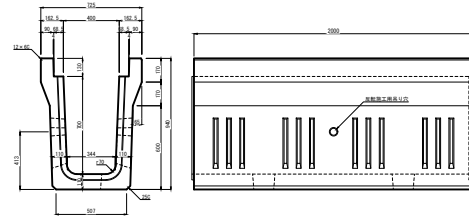

KSDS 400 × 800

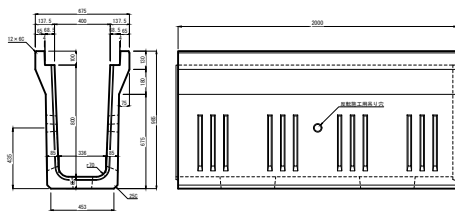

KDRS 400 × 800

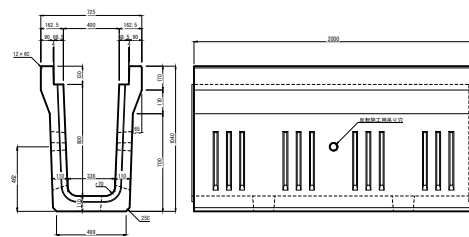

KSDS 400 × 900

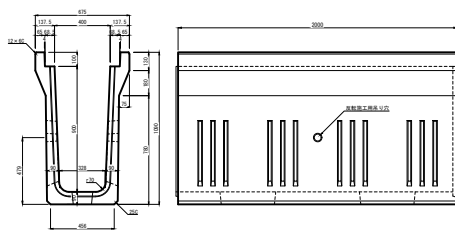

KDRS 400 × 900

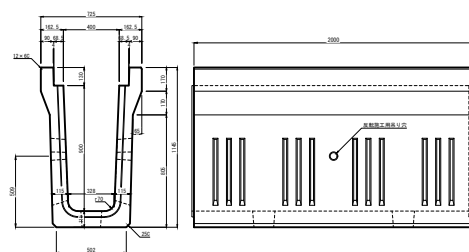

KSDS 400 × 1000

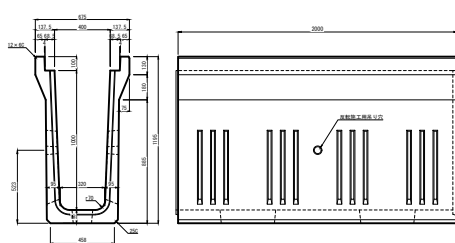

KDRS 400 × 1000

